

Drift Head-of-Wall (DHOW6-LG)

Head of wall drift and deflection clip

For attaching 20ga (33mil), 18ga (43mil) or 16ga (54mil) structural studs

ClarkDietrich Drift Head-of-wall clips are used in deflection conditions for in-fill curtain wall assemblies and/or interior nonload-bearing partitions to provide for both vertical (deflection) and lateral (drift) movement. These clips are used in place of, or in combination with, deflection track.

The Drift Head-of-wall Clips can be attached to the underside of structural members, concrete decks or floor assemblies. Structural attachments are positioned in the center of the slot to allow building drift. The "C" shaped end of the clip is slid inside of the structural stud and not fastened allowing for vertical deflection. Studs must be cut less than full height to enable vertical movement up to 2" (1" up and down).

For allowable loads for multiple connection options, reference the Clip & Connector Catalog or www.clarkdietrich.com/products/drift-head-wall-dhow for more information.

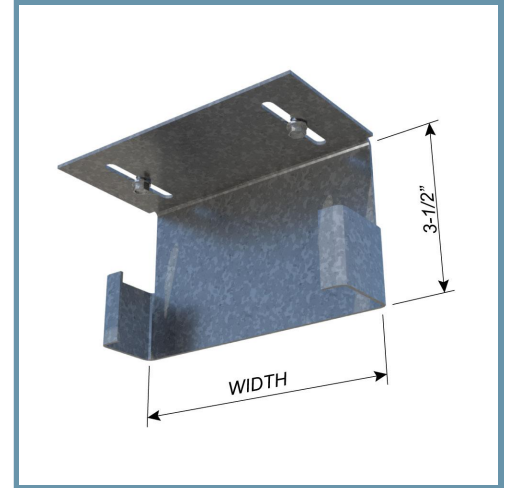

Product Data & Ordering Information:

Material:	Structural grade 50 Type H (ST50H), 50ksi (340 MPa)
Coating	G90 (Z275) hot-dipped galvanized coating
Thickness:	14ga (68mil), 0.0713" design thickness, 0.0677" min. thickness
Width:	5-7/8"
Packaging:	25 pieces per bucket
Product weight:	1.25 lb/piece

- Vertical movement up to 2" (1" up and down)
- Lateral (Drift) movement up to 2" (+/-1")
- U.S. Patent No. D839,078

Code Approvals & Performance Standards

- [ASTM A653](#) Standard Specification for Steel Sheet, Zinc-Coated (Galvanized) or Zinc-Iron Alloy-Coated (Galvannealed) by the Hot-Dip Process
- [ASTM A1003](#) Standard Specification for Steel Sheet, Carbon, Metallic- and Nonmetallic-Coated for Cold-Formed Framing Members
- [SDS For ASTM A1003 Steel Framing Products](#) For Interior Framing, Exterior Framing and Clips/Accessories

Sustainability Credits For more details and LEED letters contact Technical Services at 888-437-3244 or visit clarkdietrich.com/LEED.

- **LEED v4.1 MR Credit:** Environmental Product Declarations: EPD (1 point) - Sourcing of Raw Materials (up to 2 points) - Material Ingredients (1 point) - Construction and Demolition Waste Management (up to 2 points)
- **LEED v4 MR Credit:** Building Product Disclosure and Optimization: EPD (1 point) - Sourcing of Raw Materials (1 point) - Material Ingredients (1 point) - Construction and Demolition Waste Management (up to 2 points) - Innovation Credit (up to 2 points).

