

Drift Head-of-Wall (DHOW8-HG)

Head of wall drift and deflection clip

For attaching 14ga (68mil) or 12ga (97mil) structural studs

ClarkDietrich Drift Head-of-wall clips are used in deflection conditions for in-fill curtain wall assemblies and/or interior nonload-bearing partitions to provide for both vertical (deflection) and lateral (drift) movement. These clips are used in place of, or in combination with, deflection track.

The Drift Head-of-wall Clips can be attached to the underside of structural members, concrete decks or floor assemblies. Structural attachments are positioned in the center of the slot to allow building drift. The "C" shaped end of the clip is slid inside of the structural stud and not fastened allowing for vertical deflection. Studs must be cut less than full height to enable vertical movement up to 2" (1" up and down).

Product Data & Ordering Information:

Material: Structural grade 50 Type H (ST50H), 50ksi (340 MPa)
Coating: G90 (Z275) hot-dipped galvanized coating
Thickness: 14ga (68mil), 0.0713" design thickness, 0.0677" min. thickness
Packaging: 25 pieces per bucket
Product weight: 1.44 lb/piece

ASTM & Code Standards:

- Sheet steel meets or exceeds requirements of ASTM A1003
- Galvanized coating meets or exceeds requirements of ASTM A653
- SDS & Product Certification Information is available at www.clarkdietrich.com/SupportDocs

05.40.00 (Cold-Formed Metal Framing)

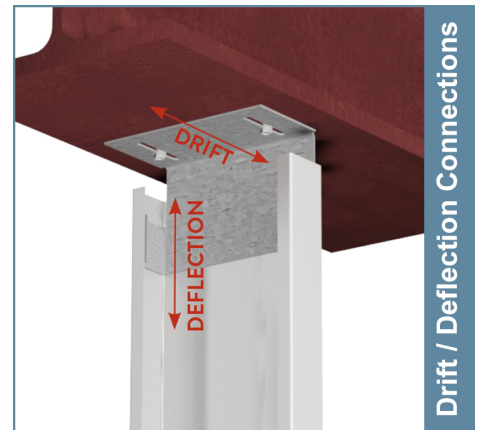

- Vertical movement up to 2" (1" up and down)
- Lateral (Drift) movement up to 2" (+/-1")
- U.S. Patent No. D839,078

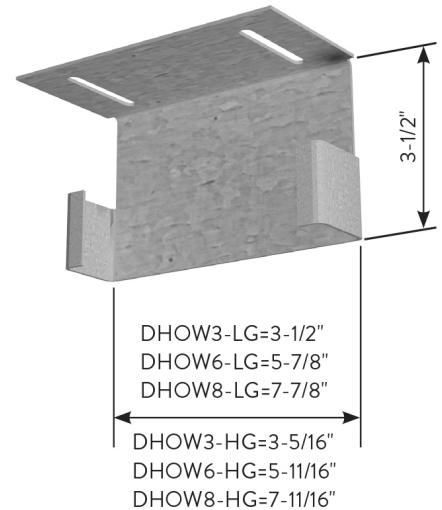

Sustainability Credits:

For more details and LEED letters contact Technical Services at 888-437-3244 or visit www.clarkdietrich.com/LEED

LEED v4 MR Credit -- Building Product Disclosure and Optimization: EPD (1 point) - Sourcing of Raw Materials (1 point) - Material Ingredients (1 point) - Construction and Demolition Waste Management (up to 2 points) - Innovation Credit (up to 2 points).

LEED 2009 Credit MR 2 & MR 4 -- ClarkDietrich's steel products are 100% recyclable and have a national average recycled content of 34.2% (19.8% post-consumer and 14.4% pre-consumer). If seeking a higher number to meet Credit MR 5, please contact us at (info@clarkdietrich.com / 888-437-3244)

Project Information

Name:
Address:

Contractor Information

Name:
Contact:
Phone:
Fax:

Architect Information

Name:
Contact:
Phone:
Fax: