

Drift Rail (DR97) and Clip (DRC8-97) for 8" Studs 12GA (97mil) Vertical / Lateral Deflection and/or Rigid Attachment

ClarkDietrich Drift Rail 97mil (12ga) and Clip 97 mil (12ga) is a uniquely designed two-piece system that is used to attach curtain-wall studs to the building structure and allows for vertical and lateral movement or to be rigidly attached. The system utilizes a C-Shaped Drift Rail and distinctively designed Drift Rail Clip that rotates into position for easy installation. The multifaceted Drift Rail Clips use FastClip Deflection Screws for attachment to the wall studs and allows for 3" vertical deflection (1-1/2" up and down) and is also designed with 1/8" holes to rigidly attach wall studs. The Drift Rail Stop is also provided when drift is not needed.

For allowable loads for multiple connection options, reference www.clarkdietrich.com/DriftRailClip for more information.

Product Data & Ordering Information:

Material	Structural Grade 50 Type H (ST50H), 50ksi (340 MPa)
Thickness	12ga (97mil), 0.1017" Design thickness, 0.0966" Min. thickness
Coating	G90 (Z275) hot-dipped galvanized coating
Clip Dimensions	1" x 4-1/2" x 8" (25.4mm x 114.3mm x 203.2mm)
Rail Dimensions	1-1/8" x 3-5/8" x 12'-0" long (28.6mm x 92.1mm x 3.658m)
Packaging	25 clips per box. (Includes 55 FastClip deflection screws per box)
	12' rail is individually packaged
Product weight	Clip = 1.47 lbs Rail = 25.21 lbs

ASTM & Code Standards:

- Sheet steel meets or exceeds requirements of ASTM A1003
- Galvanized coating meets or exceeds requirements of ASTM A653
- SDS & Product Certification Information available at www.clarkdietrich.com/SupportDocs

05.40.00 (Cold-Formed Metal Framing)

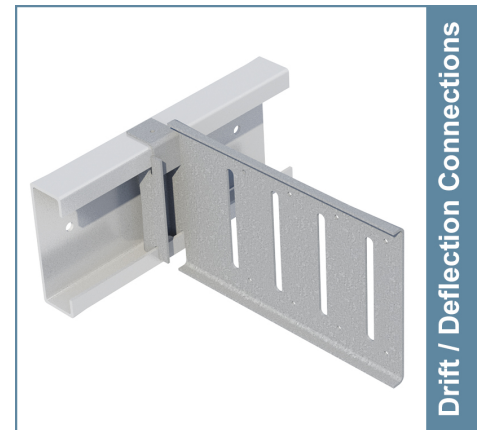

Drift / Deflection Connections

- Vertical movement up to 3" (1-1/2" up and down)
- FastClip Deflection Screws (included) provide frictionless slip connection
- Rigid attachment to studs with #10-16 screws

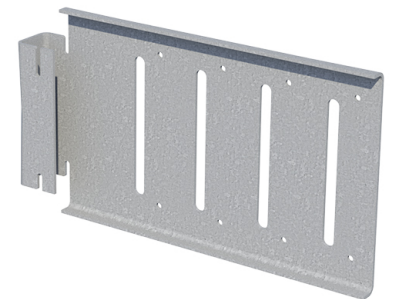

Sustainability Credits:

For more details and LEED letters contact Technical Services at 888-437-3244 or visit www.clarkdietrich.com/LEED

LEED v4 MR Credit -- Building Product Disclosure and Optimization: EPD (1 point) - Sourcing of Raw Materials (1 point) - Material Ingredients (1 point) - Construction and Demolition Waste Management (up to 2 points) - Innovation Credit (up to 2 points).

LEED 2009 Credit MR 2 & MR 4 -- ClarkDietrich's steel products are 100% recyclable and have a national average recycled content of 34.2% (19.8% post-consumer and 14.4% pre-consumer). If seeking a higher number to meet Credit MR 5, please contact us at (info@clarkdietrich.com / 888-437-3244)

Project Information

Name:
Address:

Contractor Information

Name:
Contact:
Phone:
Fax:

Architect Information

Name:
Contact:
Phone:
Fax: