

## Bridging Termination Clip (BTC6-43)

### 43mils (18ga) U-Channel Lateral Bracing Clip

The ClarkDietrich Bridging Termination clip is used to secure U-Channel or Cold Rolled Channel (CRC) to structural wall studs when used in load-bearing or curtain wall applications. (loads for structural stud gauges of 20, 18, 16, 14 & 12). The BTC's unique design allows for quicker installation in end-of-wall conditions.

The BTC is a stiffened, G90 galvanized steel clip that's tested and designed to facilitate rapid, efficient installation of 1-1/2" U-Channel lateral bracing for exterior curtain wall framing, load-bearing walls or high interior partitions constructed of structural studs.

BTC clips are fastened using #8 self-drilling screws; 2 screws between clip and U-channel and 2 screws between clip and stud flanges. Design loads & tables can be found on the 2nd page of this submittal or at [www.clarkdietrich.com/BTC](http://www.clarkdietrich.com/BTC).

The BTC clips are designed to be used with 3-5/8", 4" or 6" structural studs only.

### Product Data & Ordering Information:

<b>Material:</b>	50ksi yield strength
<b>Coating:</b>	G90
<b>Thickness:</b>	43mils (18ga), 0.0451" Design Thickness, 0.0428" Min. Thickness
<b>Dimensions:</b>	Made to fit over 1-1/2" U-Channel and around the flange of a 6" stud.
<b>Packaging:</b>	50 pieces per bucket
<b>Product weight:</b>	0.35 lb / piece

### Code Approvals & Performance Standards

- [ASTM A653](#) Standard Specification for Steel Sheet, Zinc-Coated (Galvanized) or Zinc-Iron Alloy-Coated (Galvannealed) by the Hot-Dip Process
- [ASTM A1003](#) Standard Specification for Steel Sheet, Carbon, Metallic- and Nonmetallic-Coated for Cold-Formed Framing Members
- [SDS For ASTM A1003 Steel Framing Products](#) For Interior Framing, Exterior Framing and Clips/Accessories

### Installation:

Install the BTC by sliding the flanges of the clip over the open side of the stud and positioning the clip over the CRC using the guides on the underside of the clip. Once in place, fasten to the CRC using #8 screws. Finally, fasten the flanges of the clip to the stud flange by using #8 screws.

### Alternative Products:

- [FastBridge Clip \(FB33, FB43 & FB68\)](#)
- [SwiftClip™ \(LS-Series\)](#)
- [Spazzer® 5400 Bridging Bar](#)

**Sustainability Credits** For more details and LEED letters contact Technical Services at 888-437-3244 or visit [clarkdietrich.com/LEED](http://clarkdietrich.com/LEED).

- **LEED v4.1 MR Credit:** Environmental Product Declarations: EPD (1 point) - Sourcing of Raw Materials (up to 2 points) - Material Ingredients (1 point) - Construction and Demolition Waste Management (up to 2 points)
- **LEED v4 MR Credit:** Building Product Disclosure and Optimization: EPD (1 point) - Sourcing of Raw Materials (1 point) - Material Ingredients (1 point) - Construction and Demolition Waste Management (up to 2 points) - Innovation Credit (up to 2 points).

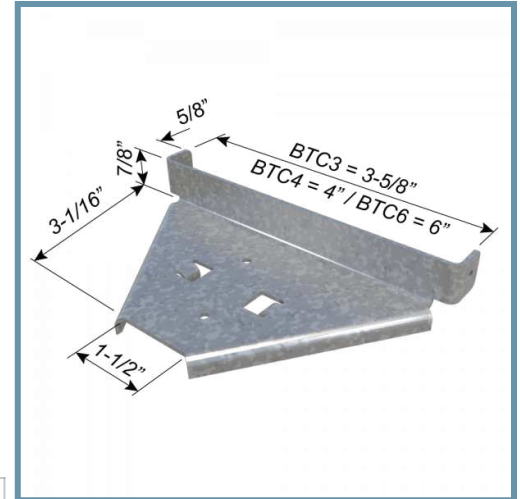

U.S. Patent No. 10,851,539 B2

