

Holdown Plate (300HDP038)

3/8" thick pre-punched shearwall holdown with bolted or welded connections

ClarkDietrich's Holdown Plates provide cost-effective shearwall attachment and are used to transfer tension loads between floors or from structural members to the foundation. HDP Holdown Plates are available in three sizes for optimal performance. Bolted installation is made easy with prepunched holes. They can be used for panelized construction or stick-built construction.

Product Data & Ordering Information:

Material:	A36, 36 ksi Yield Strength, 58 ksi Tensile Strength
Coating:	Envirocron® Powder Coating
Dimensions:	3/8" Thick 3" Wide 24" Long
Number of Holes per End	(3) 13/16" holes at Each End
Packaging:	250 pcs/skid
Product Weight:	7.75 lbs/each

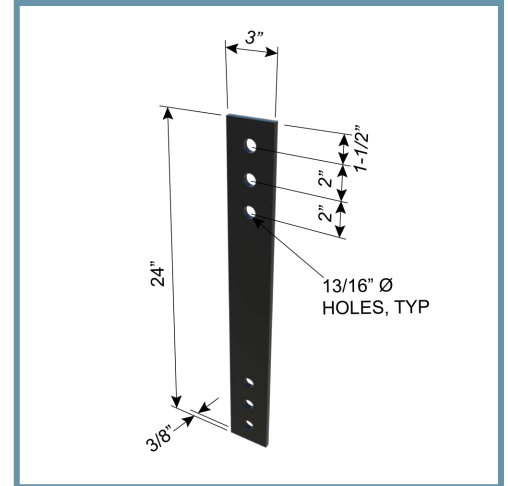

ASTM & Code Standards:

- Holdown plate capacities in compliance with AISI S100-16 (2020) and ANSI/AISC 360-16.
- SDS & Product Certification Information available at www.clarkdietrich.com/SupportDocs

Alternative Products:

- [ClarkDietrich Holdown](#)

Sustainability Credits For more details and LEED letters contact Technical Services at 888-437-3244 or visit clarkdietrich.com/LEED.

- **LEED v4.1 MR Credit:** Environmental Product Declarations: EPD (1 point) - Sourcing of Raw Materials (up to 2 points) - Material Ingredients (1 point) - Construction and Demolition Waste Management (up to 2 points)
- **LEED v4 MR Credit:** Building Product Disclosure and Optimization: EPD (1 point) - Sourcing of Raw Materials (1 point) - Material Ingredients (1 point) - Construction and Demolition Waste Management (up to 2 points) - Innovation Credit (up to 2 points).

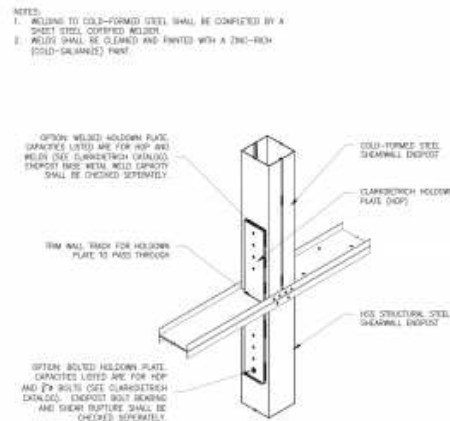
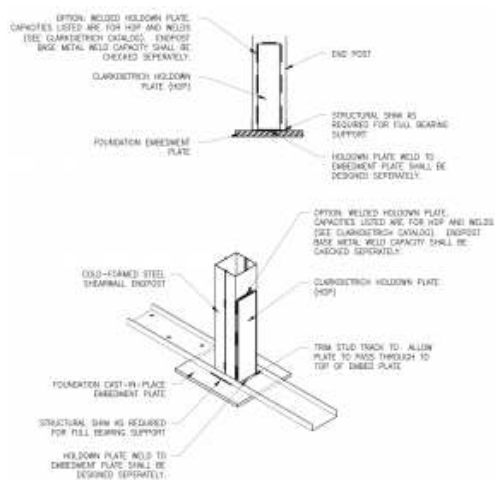
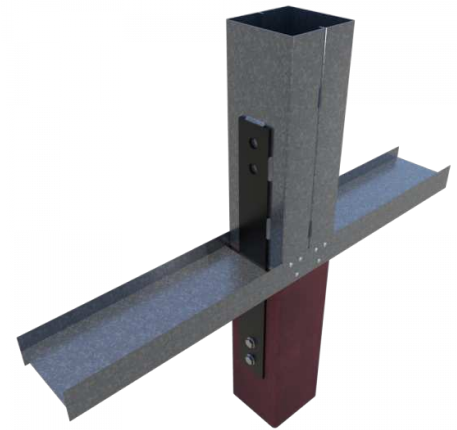

Visit our CAD Library at clarkdietrich.com to view or download construction details in .dwg, .dxd and .pdf formats