

6" Box Header Clip - 600BHC4-43

Pre-Punched clip for box headers.

The Box Header Clip (BHC) is designed to eliminate field cutting metal track into sections. The BHC clip is pre-punched to promote a quick and accurate installation. It is available in a variety of sizes and thicknesses to accommodate different application requirements.

Product Data & Ordering Information:

Material:	50 ksi
Coating:	G90 (Z275) hot-dipped galvanized coating
Thickness:	43mils (18 ga)
	0.0451" Design thickness 0.0428" Minimum thickness
Width (W):	6"
Height (H):	4"
Packaging:	100 pcs / bucket
Product Weight:	0.4330 lb / piece

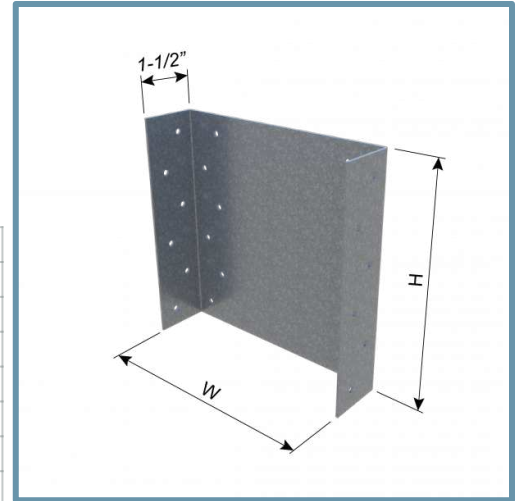

Allowable Loads:

Head Gauge (ga)	F2 (lbs) Jamb Gauge				
	20ga	18ga	16ga	14ga	12ga
20ga	990	990	990	990	990
18ga	990	1473	1473	1473	1473
16ga	990	1473	2076	2076	2076
14ga	990	1473	2076	2076	2076
12ga	990	1473	2076	2076	2076

Table Notes:

- Listed capacities are based on AISI S100-16 (2020) w/S2-20, North American Specification for Cold-Formed Steel Structural Members, AISI D114-21, Cold-Formed Steel Clip Angle Design Guide, and AISI Research Report RP18-4
- Capacities are based on #10-16 screws with an ultimate shear capacity of at least 1400 lbs.
- Capacities are based on placing #10-16 screws through all of the pre-punched holes in the connector to each side of the box header and #10-16 screws through all of the pre-punched holes in the connector to the jamb.
- Capacities are based on 20 ga. and 18 ga. 33 ksi material and 16 ga. and heavier 50 ksi material.

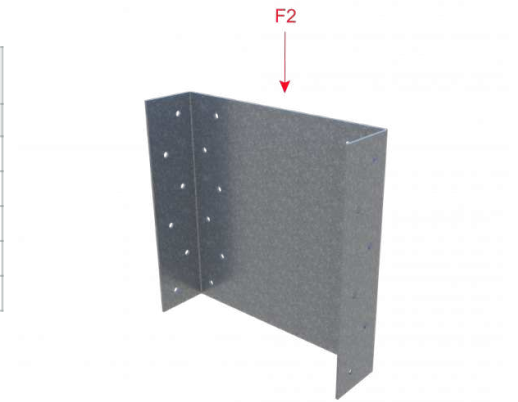

Code Approvals & Performance Standards

- [AISI S100-16 \(2020\) w/S2-20](#) North American Specification for the Design of Cold-Formed Steel Structural Members
- [AISI S240-20](#) North American Standard for Cold-Formed Steel Structural Framing
 - (Compliant to ASTM C955, but IBC replaced with AISI S200 in IBC 2015, AISI S240 in IBC 2018)
 - Section A3 Material - Chemical & mechanical requirements (Referencing ASTM A1003/A1003M)
 - Section A4 Corrosion Protection (Referencing ASTM A653/A653M)
 - Section C Installation - (Referencing ASTM C1007)
- [SDS For ASTM A1003 Steel Framing Products](#) For Interior Framing, Exterior Framing and Clips/Accessories

