

## 6" Box Header Clip - 600BHC6-43

### Pre-Punched clip for box headers.

The Box Header Clip (BHC) is designed to eliminate field cutting metal track into sections. The BHC clip is pre-punched to promote a quick and accurate installation. It is available in a variety of sizes and thicknesses to accommodate different application requirements.

### Product Data & Ordering Information:

<b>Material:</b>	50 ksi
<b>Coating:</b>	G90 (Z275) hot-dipped galvanized coating
<b>Thickness:</b>	43mils (18 ga)
	0.0451" Design thickness
	0.0428" Minimum thickness
<b>Width (W):</b>	6"
<b>Height (H):</b>	6"
<b>Packaging:</b>	100 pcs / bucket
<b>Product Weight:</b>	0.6495 lb / piece

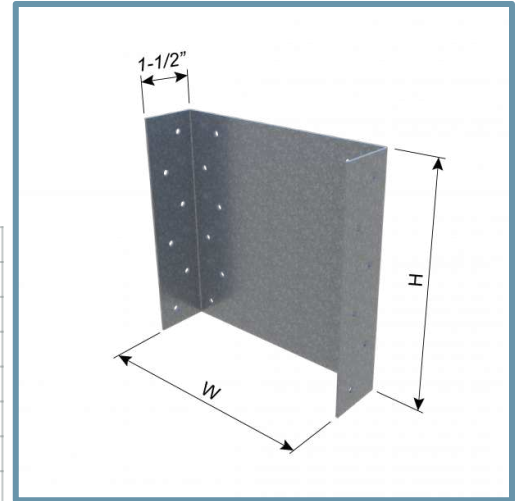

### Allowable Loads:

Head Gauge (ga)	F2 (lbs) Jamb Gauge				
	20ga	18ga	16ga	14ga	12ga
20ga	1717	1717	1717	1717	1717
18ga	1717	2555	2555	2555	2555
16ga	1717	2555	3206	3206	3206
14ga	1717	2555	3206	3206	3206
12ga	1717	2555	3206	3206	3206

#### Table Notes:

- Listed capacities are based on AISI S100-16 (2020) w/S2-20, North American Specification for Cold-Formed Steel Structural Members, AISI D114-21, Cold-Formed Steel Clip Angle Design Guide, and AISI Research Report RP18-4
- Capacities are based on #10-16 screws with an ultimate shear capacity of at least 1400 lbs.
- Capacities are based on placing #10-16 screws through all of the pre-punched holes in the connector to each side of the box header and #10-16 screws through all of the pre-punched holes in the connector to the jamb.
- Capacities are based on 20 ga. and 18 ga. 33 ksi material and 16 ga. and heavier 50 ksi material.

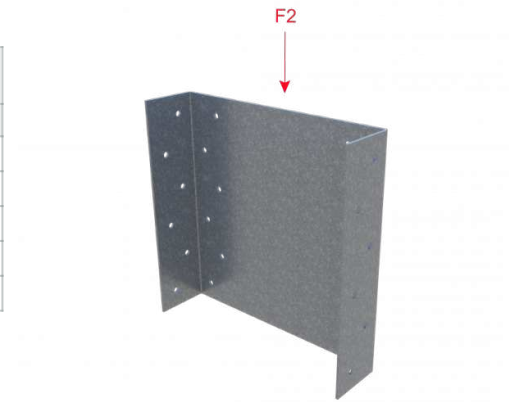

### Code Approvals & Performance Standards

- [AISI S100-16 \(2020\) w/S2-20](#) North American Specification for the Design of Cold-Formed Steel Structural Members
- [AISI S240-20](#) North American Standard for Cold-Formed Steel Structural Framing
  - (Compliant to ASTM C955, but IBC replaced with AISI S200 in IBC 2015, AISI S240 in IBC 2018)
  - Section A3 Material - Chemical & mechanical requirements (Referencing ASTM A1003/A1003M)
  - Section A4 Corrosion Protection (Referencing ASTM A653/A653M)
  - Section C Installation - (Referencing ASTM C1007)
- [SDS For ASTM A1003 Steel Framing Products](#) For Interior Framing, Exterior Framing and Clips/Accessories

