

Bridle Hanger (CDBV, CDMB)

4-1/8" Wide x 8" Deep 12ga (97mil) Floor Joist Hanger

Bridle Hangers are commonly used to attach light-gauge C-joists to structural steel beams or wood ledgers. Connections can be made with screws, powder-actuated fasteners, drill-in concrete anchors or welding.

Single and double-wide bridle hangers are also available in other widths and depths.

Product Data & Ordering Information:

Material:	Structural Grade 50 Type H (ST50H), 50ksi (340 MPa)
Coating:	G90 (Z275) hot-dipped galvanized coating
Thickness:	12ga (97mil) 0.1017" Design thickness 0.0966" Minimum thickness
Dimensions:	4" wide x 8" deep (101.6mm x 203.2mm)
Packaging:	15 pieces per carton
Product Weight:	1.25 lb / piece

Installation:

Attach bridle hanger to the primary frame as specified. When welding the hanger to the primary frame, a minimum of 1/8" x 2" fillet weld on each top flange is required. Distribute the weld equally on both top flanges. Uplift loads do not apply to weld on applications. Place joist into hanger and secure with fasteners. If bridle hanger is less than beam depth, provide back blocking.

Code Approvals & Performance Standards

- [ASTM A653](#) Standard Specification for Steel Sheet, Zinc-Coated (Galvanized) or Zinc-Iron Alloy-Coated (Galvannealed) by the Hot-Dip Process
- [ASTM A1003](#) Standard Specification for Steel Sheet, Carbon, Metallic- and Nonmetallic-Coated for Cold-Formed Framing Members
- [SDS For ASTM A1003 Steel Framing Products](#) For Interior Framing, Exterior Framing and Clips/Accessories

Sustainability Credits For more details and LEED letters contact Technical Services at 888-437-3244 or visit clarkdietrich.com/LEED.

- **LEED v4.1 MR Credit:** Environmental Product Declarations: EPD (1 point) - Sourcing of Raw Materials (up to 2 points) - Material Ingredients (1 point) - Construction and Demolition Waste Management (up to 2 points)
- **LEED v4 MR Credit:** Building Product Disclosure and Optimization: EPD (1 point) - Sourcing of Raw Materials (1 point) - Material Ingredients (1 point) - Construction and Demolition Waste Management (up to 2 points) - Innovation Credit (up to 2 points).

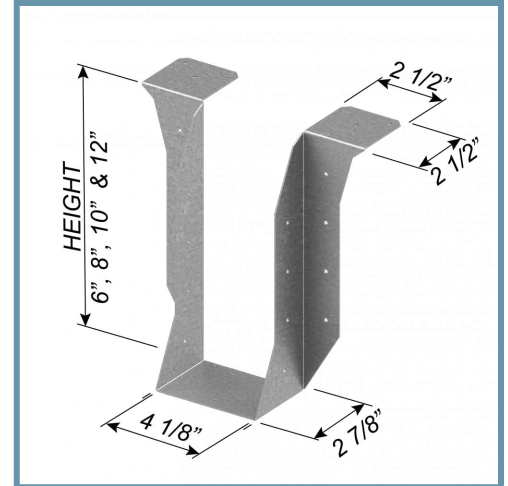

- Available in 68mils (14ga) or 97mils (12ga)
- Available in 1-5/8", 2" or 4" widths
- Fits Joists Sizes From 6" to 12"

