

Header Cripple Stud Clip (RCSC-68)

14ga (68mil) Support Clip

Header Cripple Stud Clips are used with RedHeader Pro and HDS and remove the need for a header track. The L-shaped clips install on the back side of the cripple stud, therefore shorter length clips do not need to be ordered. These labor time-savers include prepunched holes for quicker screw attachments, and are punched for RedHeader Pro and HDS connections.

Product Data & Ordering Information:

Material:	Structural Grade 50 Type H (ST50H), 50ksi (340 MPa)
Coating:	G90 (Z275) hot-dipped galvanized coating
Thickness:	14ga (68mil) 0.0713" Design thickness 0.0677" Minimum thickness
Dimensions:	1-1/2" x 1-1/2" x 7-3/4" (38.1mm x 38.1mm x 197.9mm)
Packaging:	100 pieces per bucket
Product Weight:	.45 lb / piece

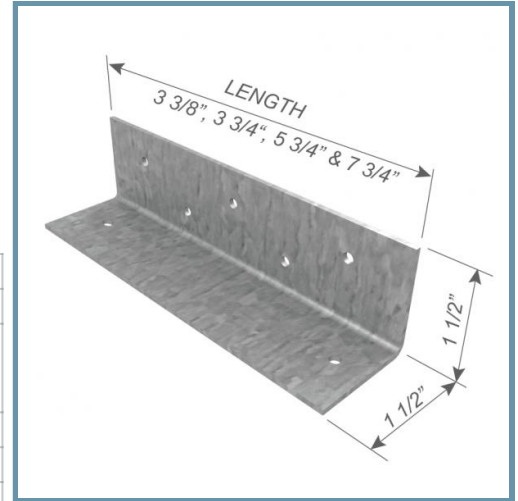

- Available in 16 & 14 gauge
- Pre-punched for faster and more accurate fastener attachment

Code Approvals & Performance Standards

- [ASTM A653](#) Standard Specification for Steel Sheet, Zinc-Coated (Galvanized) or Zinc-Iron Alloy-Coated (Galvannealed) by the Hot-Dip Process
- [ASTM A1003](#) Standard Specification for Steel Sheet, Carbon, Metallic- and Nonmetallic-Coated for Cold-Formed Framing Members
- [SDS For ASTM A1003 Steel Framing Products](#) For Interior Framing, Exterior Framing and Clips/Accessories

Alternative Products:

- Installation of header track

Sustainability Credits For more details and LEED letters contact Technical Services at 888-437-3244 or visit clarkdietrich.com/LEED.

- **LEED v4.1 MR Credit:** Environmental Product Declarations: EPD (1 point) - Sourcing of Raw Materials (up to 2 points) - Material Ingredients (1 point) - Construction and Demolition Waste Management (up to 2 points)
- **LEED v4 MR Credit:** Building Product Disclosure and Optimization: EPD (1 point) - Sourcing of Raw Materials (1 point) - Material Ingredients (1 point) - Construction and Demolition Waste Management (up to 2 points) - Innovation Credit (up to 2 points).

