

TradeReady® Floor Joist Blocking (1000JB) For 10" Deep Joists

Quick and efficient system that prevents joist rotation and accommodates mechanical passing

TradeReady Floor Joist Blocking is one of the primary components that make up the TradeReady floor bracing system. TradeReady Blocking features a large extruded hole to accommodate HVAC, mechanical, plumbing and sprinkler runs.

TradeReady Blocking is pre-cut and formed to fit securely between the floor joists to prevent joist rotation. Pre-punched holes in the connection legs are added for quick attachment to each floor joist. Structural blocking is an economical alternative to Tension Bracing or blocking /strapping.

Product Data & Ordering Information:

Material: 50ksi yield strength
 Coating: G90
 Thickness: 54mils (16a) - 0.0566" design thickness, 0.0538" minimum thickness
 Dimensions: Length: Based on spacing: 12", 16" or 24" long.
 Depth: 10" on one end same as joist depth
 Notched end = 8" to fit inside joist flanges
 Connection legs = 3" wide
 Hole Size = 6-1/2" x 9"

Packaging: 10 pieces per carton
 Weight: Based on length: 12" = 2.31 lbs, 16" = 3.09 lbs, 24" = 4.85 lbs / Each

ASTM & Code Standards:

- Sheet steel meets or exceeds mechanical and chemical requirements of ASTM A1003
- TradeReady Floor Joist Blocking complies with International Residential Code (Section R505.3), for solid blocking in steel floor joist systems.
- SDS & Product Certification Information is available at www.clarkdietrich.com/SupportDocs

Installation:

Place the notched end of the TradeReady Blocking inside the open side of one floor joist. Attached each end of the TradeReady Blocking to each floor joist with (2) #10-16 screws in pre-punched holes.

Alternative Products:

- Tension Bracing (CDTB)
- Diagonal Tension Strapping

05.40.00 (Cold-Formed Metal Framing)

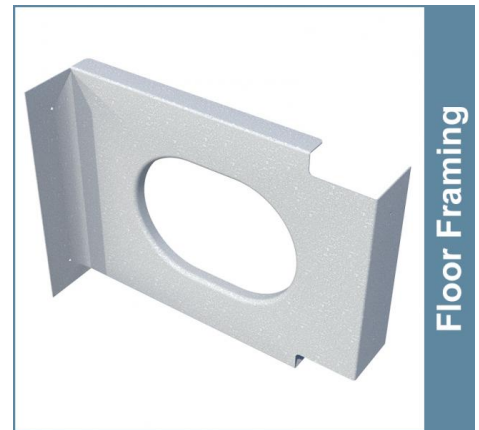

Floor Framing

- Pre-cut to fit 12", 16", or 24" joist spacing
- Pre-punched holes for quick attachment to floor joists

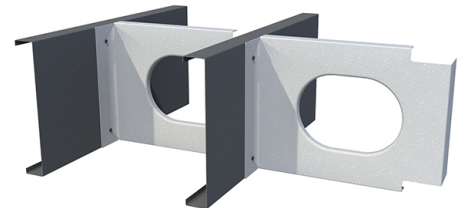

Sustainability Credits:

For more details and LEED letters contact Technical Services at 888-437-3244 or visit www.clarkdietrich.com/LEED

LEED v4 MR Credit -- Building Product Disclosure and Optimization: EPD (1 point) - Sourcing of Raw Materials (1 point) - Material Ingredients (1 point) - Construction and Demolition Waste Management (up to 2 points) - Innovation Credit (up to 2 points).

LEED 2009 Credit MR 2 & MR 4 -- ClarkDietrich's steel products are 100% recyclable and have a national average recycled content of 34.2% (19.8% post-consumer and 14.4% pre-consumer). If seeking a higher number to meet Credit MR 5, please contact us at (info@clarkdietrich.com / 888-437-3244)

Project Information

Name:
Address:

Contractor Information

Name:
Contact:
Phone:
Fax:

Architect Information

Name:
Contact:
Phone:
Fax: