

"F" Channel Reveal - Surface Mount

Provide a reveal at the juncture of walls, ceilings, or dissimilar materials

Surface-mounted reveal used at the juncture of walls, ceilings, or other dissimilar materials. Always use a rigid backing or blocking material behind surface-mounted reveals. Vent clips are provided with vented channel reveals to connect reveal sections and to assist in alignment. Caulk all intersections, butt joints, ends, and corners at the time of installation. Not to be used in lieu of control joints or expansion joints. Factory fabricated intersections are also available for all ClarkDietrich channel reveals.

Product Data & Ordering Information:

Product Code	Finish	Min Board	Reveal	Perforated	PCS/Box
	Thickness	Thickness (A)	(B)	Flanges (C)	
FDC58-25SE	1/16" - 3/32"	5/8"	1/4"	1-1/8"	35
FDC58-38SE	1/16" - 3/32"	5/8"	3/8"	1-1/8"	35
FDC58-50SE	1/16" - 3/32"	5/8"	1/2"	1-1/8"	30
FDC58-75SE	1/16" - 3/32"	5/8"	3/4"	1-1/8"	25
FDC58-100SE	1/16" - 3/32"	5/8"	1"	1-1/8"	25
FDC58-150SE	1/16" - 3/32"	5/8"	1-1/2"	1-1/8"	20
FDC58-200SE	1/16" - 3/32"	5/8"	2"	1-1/8"	20

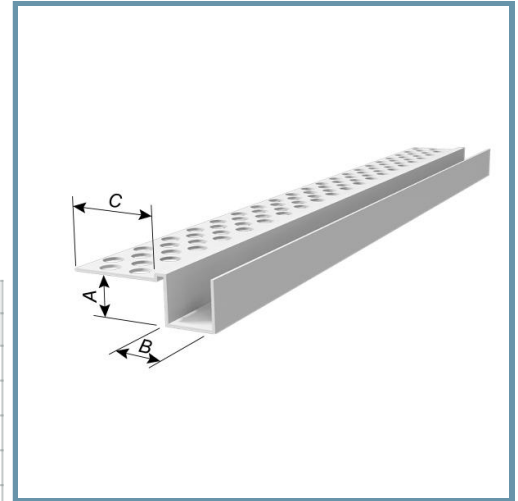

Made in white or these standard thru-body colors:

Tan Brown Gray Black

Contact ClarkDietrich for pricing and availability

Code Approvals & Performance Standards

- [ASTM D1784](#) Standard Classification System and Basis for Specification for Rigid Poly(Vinyl Chloride) (PVC) Compounds and Chlorinated Poly(Vinyl Chloride) (CPVC) Compounds
- [ASTM D4216](#) Standard Specification for Rigid Poly(Vinyl Chloride) (PVC) and Related PVC and Chlorinated Poly(Vinyl Chloride) (CPVC) Building Products Compounds
- [ASTM E2110](#) Standard Terminology for Exterior Insulation and Finish Systems (EIFS)
- [ASTM E2273](#) Standard Test Method for Determining the Drainage Efficiency of Exterior Insulation and Finish Systems (EIFS) Clad Wall Assemblies
- [ASTM E2486](#) Standard Test Method for Impact Resistance of Class PB and PI Exterior Insulation and Finish Systems (EIFS)
- [ASTM E2511](#) Standard Guide for Detailing of EIFS-Clad Barrier and Drainage Wall Assemblies
- [ASTM E2568](#) Standard Specification for PB Exterior Insulation and Finish Systems
- [SDS Vinyl Corp](#) PVC Compounds

Storage

All stored materials shall be kept dry. Materials shall be stacked off the ground, supported on a level platform, and protected from the weather.

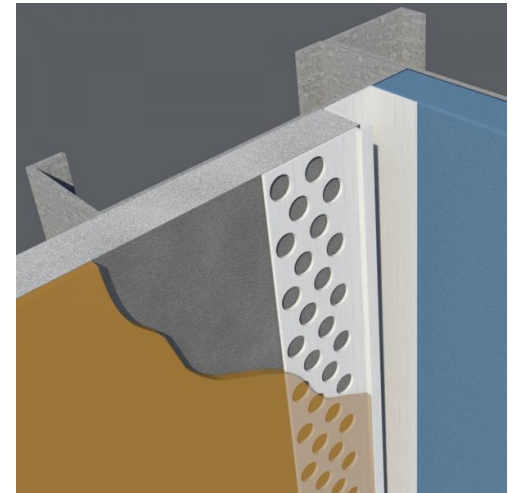

- Available for board thicknesses of 1/2" and 5/8"