

EasyClip™ E-Series™ (E549)

54mils (16ga) Support Clip

ClarkDietrich EasyClip E-Series support clips are primarily used for rigid stand-off connections. The 4" wide leg provides extra length to achieve stand-off connections up to 3". The EasyClip E-Series support clips are also commonly used in bypass wall conditions, a variety of floor framing applications including solid and ladder blocking attachments and joist-to-joist connections, and to secure rafter framing to the primary structure. Available in a variety of lengths and gauges, these clips are prepunched for faster and more accurate fastener placement.

For allowable loads for multiple connection options, reference the Clip & Connector Catalog or www.clarkdietrich.com for more information.

Product Data & Ordering Information:

Material:	Structural Grade 50 Type H (ST50H), 50ksi (340 MPa)
Coating:	G90 (Z275) hot-dipped galvanized coating
Thickness:	54mils (16ga) 0.0566" Design thickness 0.0538" Minimum thickness
Dimensions:	4" x 1-1/2" x 9" (102mm x 38.1mm x 229mm)
Packaging:	50 pieces per bucket
Product Weight:	0.80 lb / piece

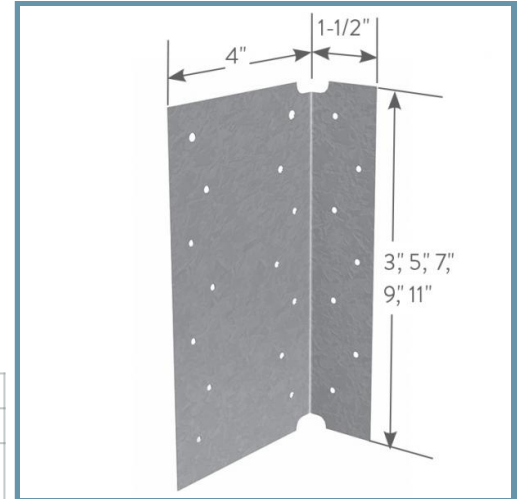

- 4" leg for large standoff
- Available lengths: 3", 5", 7", 9" & 11"
- Available in 16, 14 & 12 gauge
- Pre-punched for faster and more accurate fastener attachment

Code Approvals & Performance Standards

- [ASTM A653](#) Standard Specification for Steel Sheet, Zinc-Coated (Galvanized) or Zinc-Iron Alloy-Coated (Galvannealed) by the Hot-Dip Process
- [ASTM A1003](#) Standard Specification for Steel Sheet, Carbon, Metallic- and Nonmetallic-Coated for Cold-Formed Framing Members
- [SDS For ASTM A1003 Steel Framing Products](#) For Interior Framing, Exterior Framing and Clips/Accessories

Alternative Products:

- [UniClip™](#), [EasyClip™ D-Series™ Anchor Clip](#)
- [EasyClip™ T-Series™ Tall Anchor Angle](#)
- [EasyClip™ E-Series™ Support Clip](#)

Sustainability Credits For more details and LEED letters contact Technical Services at 888-437-3244 or visit clarkdietrich.com/LEED.

- **LEED v4.1 MR Credit:** Environmental Product Declarations: EPD (1 point) - Sourcing of Raw Materials (up to 2 points) - Material Ingredients (1 point) - Construction and Demolition Waste Management (up to 2 points)
- **LEED v4 MR Credit:** Building Product Disclosure and Optimization: EPD (1 point) - Sourcing of Raw Materials (1 point) - Material Ingredients (1 point) - Construction and Demolition Waste Management (up to 2 points) - Innovation Credit (up to 2 points).

