

1-1/2" x 1-1/2" SwiftClip™ LS Series™ (LS971)

12ga (97mil) 11-1/4" Long Support Clip

SwiftClip LS Series support clips are used in multiple construction projects, specifically in conjunction with structural studs and track. The L-shaped clips fit between the stud flanges, so that shorter length clips do not need to be ordered. These labor time-savers include prepunched holes for quicker screw attachments, and are punched to accommodate for CRC lateral bracing connections.

For allowable loads for multiple connection options, reference the Clip & Connector Catalog or www.clarkdietrich.com/SwiftClip for more information.

Product Data & Ordering Information:

Material:	Structural Grade 50 Type H (ST50H), 50ksi (340 MPa)
Coating:	G90 (Z275) hot-dipped galvanized coating
Thickness:	12ga (97mil) 0.1017" Design thickness 0.0966" Minimum thickness
Dimensions:	1-1/2" x 1-1/2" x 11-1/4" (38.1mm x 38.1mm x 286mm)
Packaging:	50 pieces per bucket
Product Weight:	0.93 lb / piece

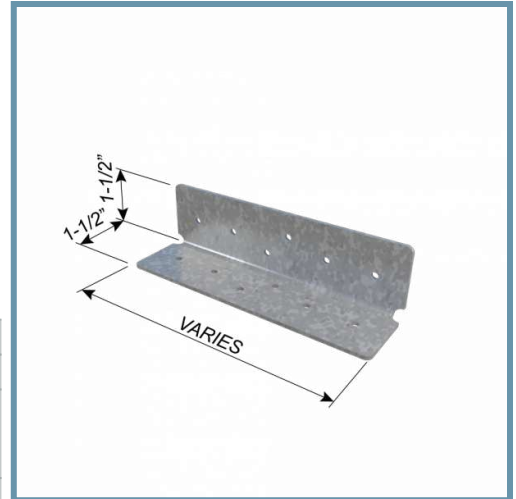

- Lengths Available: 3-1/4", 5-1/2", 7-1/4", 9-1/4", 11-1/4" & 13-1/4"
- Available in 16, 14 & 12 gauge
- Pre-punched for faster and more accurate fastener attachment

Code Approvals & Performance Standards

- [ASTM A653](#) Standard Specification for Steel Sheet, Zinc-Coated (Galvanized) or Zinc-Iron Alloy-Coated (Galvannealed) by the Hot-Dip Process
- [ASTM A1003](#) Standard Specification for Steel Sheet, Carbon, Metallic- and Nonmetallic-Coated for Cold-Formed Framing Members
- [SDS For ASTM A1003 Steel Framing Products](#) For Interior Framing, Exterior Framing and Clips/Accessories

Alternative Products:

- [FastBridge™ Clip](#)
- [EasyClip™ Support Clips](#)

Sustainability Credits For more details and LEED letters contact Technical Services at 888-437-3244 or visit clarkdietrich.com/LEED.

- **LEED v4.1 MR Credit:** Environmental Product Declarations: EPD (1 point) - Sourcing of Raw Materials (up to 2 points) - Material Ingredients (1 point) - Construction and Demolition Waste Management (up to 2 points)
- **LEED v4 MR Credit:** Building Product Disclosure and Optimization: EPD (1 point) - Sourcing of Raw Materials (1 point) - Material Ingredients (1 point) - Construction and Demolition Waste Management (up to 2 points) - Innovation Credit (up to 2 points).

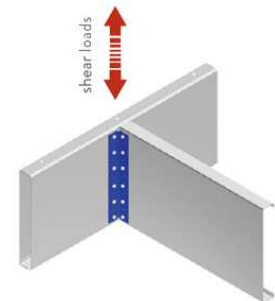

Joist-to-Joist Connections

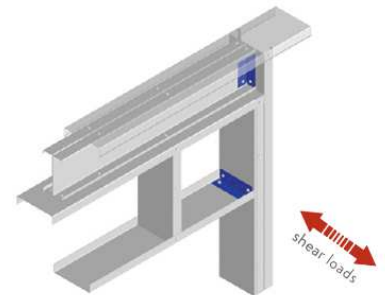

Head-to-Jamb Connections

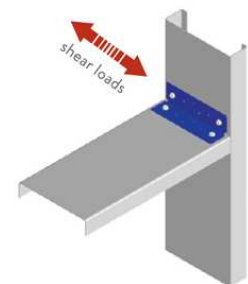

Sill-to-Jamb Connections