

LS975 SwiftClip™ LS Series™ 12 Gauge (97mil) Support Clip

SwiftClip L-Series support clips are used in multiple construction projects, specifically in conjunction with structural studs and track. The L-shaped clips fit between the stud flanges, so that shorter length clips do not need to be ordered. These labor time-savers include prepunched holes for quicker screw attachments, and are punched to accommodate for CRC lateral bracing connections.

For allowable loads for multiple connection options, reference the Clip & Connector Catalog or www.clarkdietrich.com/SwiftClip for more information.

Product Data & Ordering Information:

Material:	Structural Grade 50 Type H (ST50H), 50ksi (340 MPa)
Coating:	G90 (Z275) hot-dipped galvanized coating
Thickness:	12 Gauge (97mil) 0.1017" Design thickness 0.0966" Minimum thickness
Dimensions:	1-1/2" x 1-1/2" x 5-1/2" (38.1mm x 38.1mm x 140mm)
Packaging:	100 pieces per bucket
Product Weight:	0.45 lb / piece

ASTM & Code Standards:

- Sheet steel meets or exceeds requirements of ASTM A1003
- Galvanized coating meets or exceeds requirements of ASTM A653
- SDS & Product Certification Information available at www.clarkdietrich.com/SupportDocs

Alternative Products:

- EasyClip™ E or S-Series™ Support Clip
- EasyClip™ B, U or X-Series™ Clip Angle
- EasyClip™ A-Series™ End Clip

05.40.00 (Cold-Formed Metal Framing)

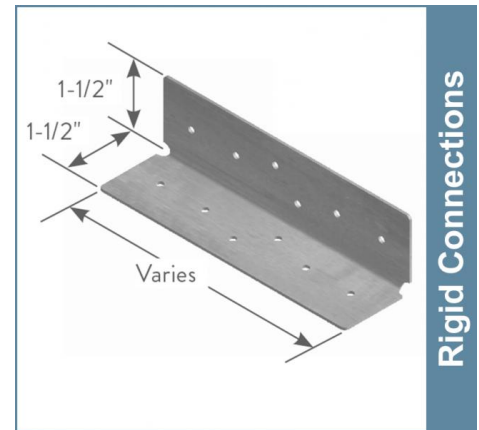

- 1-1/2" x 1-1/2" legs
- Lengths Available: 3-1/4", 5-1/2", 7-1/4", 9-1/4", 11-1/4" & 13-1/4"
- Available in 16, 14 & 12 gauge
- Pre-punched for faster and more accurate fastener attachment

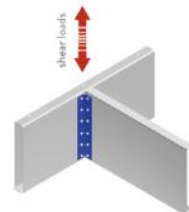

Joist-to-Joist Connections

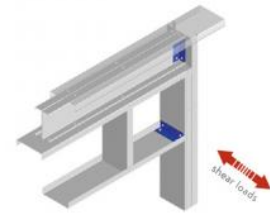

Head-to-Jamb Connections

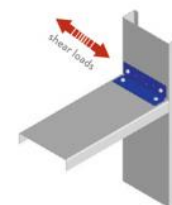

Sill-to-Jamb Connections

Sustainability Credits:

For more details and LEED letters contact Technical Services at 888-437-3244 or visit www.clarkdietrich.com/LEED

LEED v4 MR Credit -- Building Product Disclosure and Optimization: EPD (1 point) - Sourcing of Raw Materials (1 point) - Material Ingredients (1 point) - Construction and Demolition Waste Management (up to 2 points) - Innovation Credit (up to 2 points).

LEED 2009 Credit MR 2 & MR 4 -- ClarkDietrich's steel products are 100% recyclable and have a national average recycled content of 34.2% (19.8% post-consumer and 14.4% pre-consumer). If seeking a higher number to meet Credit MR 5, please contact us at (info@clarkdietrich.com / 888-437-3244)

Project Information

Name:
Address:

Contractor Information

Name:
Contact:
Phone:
Fax:

Architect Information

Name:
Contact:
Phone:
Fax: