

## Universal Joist Hanger (UJH-97) 12 Gauge (97mil) Floor Joist Hanger

ClarkDietrich's Universal Joist Hangers (UJH) are used to connect joists to CFS headers (with screws, welds or PAF fasteners) and steel I-beams (with welds or PAF fasteners). The UJH is sized to fit joist sizes from 8" to 14" deep.

For allowable loads for multiple connection options, reference [www.clarkdietrich.com/UJH](http://www.clarkdietrich.com/UJH) for more information.

### Product Data & Ordering Information:

Material:	Structural Grade 50 Type H (ST50H), 50ksi (340 MPa)
Coating:	G90 (Z275) hot-dipped galvanized coating
Thickness:	12 Gauge (97mil) 0.1017" Design thickness 0.0966" Minimum thickness
Dimensions:	4" x 7-1/2" long (101.6mm x 190.5mm)
Packaging:	50 pieces per bucket
Product Weight:	1.04 lb / piece

### ASTM & Code Standards:

- Sheet steel meets or exceeds requirements of ASTM A1003
- Galvanized coating meets or exceeds requirements of ASTM A653
- SDS & Product Certification Information available at [www.clarkdietrich.com/SupportDocs](http://www.clarkdietrich.com/SupportDocs)

### 05.40.00 (Cold-Formed Metal Framing)



- Available in 68mils (14ga) or 97mils (12ga)
- Fits Joists Sizes From 8" to 14"

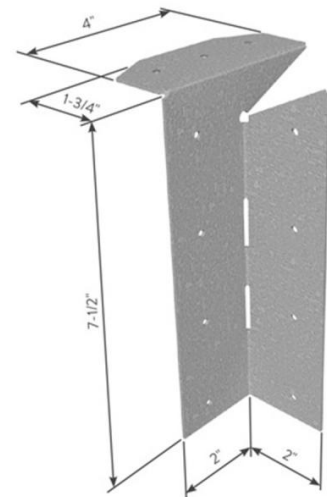

### Sustainability Credits:

For more details and LEED letters contact Technical Services at 888-437-3244 or visit [www.clarkdietrich.com/LEED](http://www.clarkdietrich.com/LEED)

**LEED v4 MR Credit** -- Building Product Disclosure and Optimization: EPD (1 point) - Sourcing of Raw Materials (1 point) - Material Ingredients (1 point) - Construction and Demolition Waste Management (up to 2 points) - Innovation Credit (up to 2 points).

**LEED 2009 Credit MR 2 & MR 4** -- ClarkDietrich's steel products are 100% recyclable and have a national average recycled content of 34.2% (19.8% post-consumer and 14.4% pre-consumer). If seeking a higher number to meet Credit MR 5, please contact us at ([info@clarkdietrich.com](mailto:info@clarkdietrich.com) / 888-437-3244)

### Project Information

Name:  
Address:

### Contractor Information

Name:  
Contact:  
Phone:  
Fax:

### Architect Information

Name:  
Contact:  
Phone:  
Fax: