

12" Extended Uni-Clip™ (UXRC-12) 14 Gauge (68mil) Extended Rigid Connection Clip

ClarkDietrich's Extended Uni-Clip rigid framing clip is used to attach exterior wall studs to the structure of the building. Designed to transfer horizontal and vertical loads, the extended rigid clips install easily with screws, powder-actuated fasteners, or welds. This clip is ideal for all medium and large standoff conditions.

Attach the Extended Uni-Clip rigid clips to cold-formed steel framing members using #12 minimum self-drilling screws driven through the clip holes into the steel framing. Follow the required fastener placement patterns to achieve the allowable load. Connections to the primary building frame can also be made with powder-actuated fasteners or welds per design requirement.

For allowable loads for multiple connection options, reference the Clip & Connector Catalog or www.clarkdietrich.com for more information.

Product Data & Ordering Information:

Material:	Structural Grade 50 Type H (ST50H), 50ksi (340 MPa)
Coating:	G90 (Z275) hot-dipped galvanized coating
Thickness:	14 Gauge (68mil) 0.0713" Design thickness 0.0677" Minimum thickness
Dimensions:	1-7/8" x 4-7/8" x 12" (47.6mm x 124mm x 305mm)
Packaging:	25 pieces per bucket
Product Weight:	1.64 lb / piece

ASTM & Code Standards:

- Sheet steel meets or exceeds requirements of ASTM A1003
- Galvanized coating meets or exceeds requirements of ASTM A653
- SDS & Product Certification Information available at www.clarkdietrich.com/SupportDocs

05.40.00 (Cold-Formed Metal Framing)



- Designed to transfer large horizontal and vertical loads
- Universal multi-application connector
- Ideal for medium and large standoff conditions

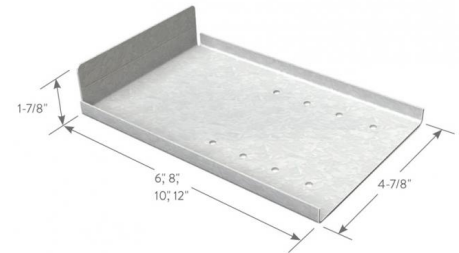

Sustainability Credits:

For more details and LEED letters contact Technical Services at 888-437-3244 or visit www.clarkdietrich.com/LEED

LEED v4 MR Credit -- Building Product Disclosure and Optimization: EPD (1 point) - Sourcing of Raw Materials (1 point) - Material Ingredients (1 point) - Construction and Demolition Waste Management (up to 2 points) - Innovation Credit (up to 2 points).

LEED 2009 Credit MR 2 & MR 4 -- ClarkDietrich's steel products are 100% recyclable and have a national average recycled content of 34.2% (19.8% post-consumer and 14.4% pre-consumer). If seeking a higher number to meet Credit MR 5, please contact us at (info@clarkdietrich.com / 888-437-3244)

Project Information

Name:
Address:

Contractor Information

Name:
Contact:
Phone:
Fax:

Architect Information

Name:
Contact:
Phone:
Fax: