

U-Channel (CRC)

Product category	2" U-Channel / CRC - 16ga
Product name	200U50-54 (33ksi) - Unpunched, 54mils
Finish	G40, CP60 or G90
Color coding	Green

Geometric Properties

Web depth	2.000 in
Leg width	0.500 in
Design thickness	0.0566 in
Min. steel thickness	0.0538 in
Yield stress, Fy	33ksi, *Fy with Cold-Work, Fya 39.4 ksi
Ultimate, Fu	45 ksi

Gross Section Properties of Full Section, Strong Axis

Cross sectional area (A)	0.158 in ⁽²⁾
Member weight per foot of length	0.537 lb/ft
Moment of inertia (Ix)	0.080 in ⁽⁴⁾
Radius of gyration (Rx)	0.711 in
Gross moment of inertia (Iy)	0.003 in ⁽⁴⁾
Gross radius of gyration (Ry)	0.137 in

Effective Section Properties, Strong Axis

Moment of inertia for deflection (Ix)	0.080 in ⁽⁴⁾
Section modulus (Sx)	0.080 in ⁽³⁾
Allowable bending moment (Ma)	1.883 in-k
Allowable shear force (Va)	1190 lb

Product Data & Ordering Information:

Length	10'-0" long pieces (Custom length available by special orders)
Packaging	10 pieces per bundle - 240 pieces per pallet
Packaging weight	54 lbs/bundle

Code Approvals & Performance Standards:

AISI S100-16 North American Specification for the Design of CFS Structural Members

AISI S240-15 North American Standard for Cold-Formed Steel Structural Framing

- Section A3 - Material - Chemical & mechanical requirements (Referencing ASTM A1003 / A1003M)
- Section A4 - Corrosion Protection (Referencing ASTM A653 / A653M)
- Section C - Installation - (Referencing ASTM C1007)

SDS & Product Certification Information is available at www.clarkdietrich.com/SupportDocs

05.40.00 (Cold-Formed Metal Framing)

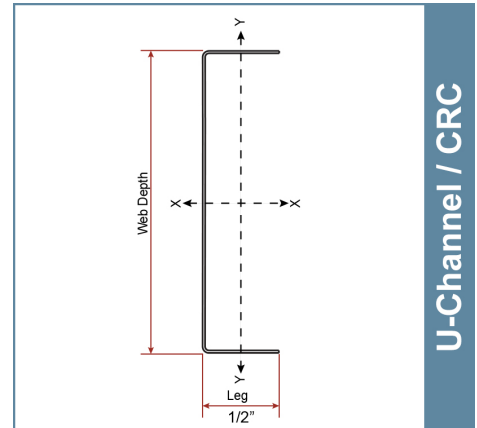

U-Channel / CRC

Used in framing applications:

- Furring for metal lath systems
- Drop down ceilings
- For oversized knockouts

Sustainability Credits For more details and LEED letters contact Technical Services at 888-437-3244 or visit clarkdietrich.com/LEED.

LEED v4.1 MR Credit: Environmental Product Declarations: EPD (1 point) - Sourcing of Raw Materials (up to 2 points) - Material Ingredients (1 point) - Construction and Demolition Waste Management (up to 2 points)

LEED v4 MR Credit: Building Product Disclosure and Optimization: EPD (1 point) - Sourcing of Raw Materials (1 point) - Material Ingredients (1 point) - Construction and Demolition Waste Management (up to 2 points) - Innovation Credit (up to 2 points).

Project Information

Name:
Address:

Contractor Information

Name:
Contact:
Phone:
Fax:

Architect Information

Name:
Contact:
Phone:
Fax: